



HD Display



Infrared Touch



System Optional

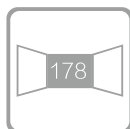

178° full viewing angle



Centralized Terminal Management



Split Screen Playback



3D Noise Reduction Display

450cd/m² IPS Panel

Commercial grade IPS technology accurately displays image quality and colour depth with no fall-off in colour accuracy. These panels are designed to achieve ultimate lifelike colour temperature in portrait orientation.

Internal Locker

Should you need to run the screen from an external source, like a PC or media player, you can do so by using the HDMI input or the VGA and 5mm audio jack inputs.

Free Scheduling Software

These displays come with free scheduling software for displaying different content at different times of the day. If you prefer to keep it simple you can update the screen directly without using the software.

Optional Network Upgrade

For a small charge you can upgrade your screen to be networked, allowing you to connect your screen via WiFi, LAN or 4G, then remotely update it over the internet.



Specifications (No Touch)

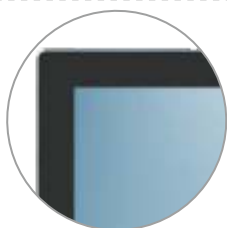
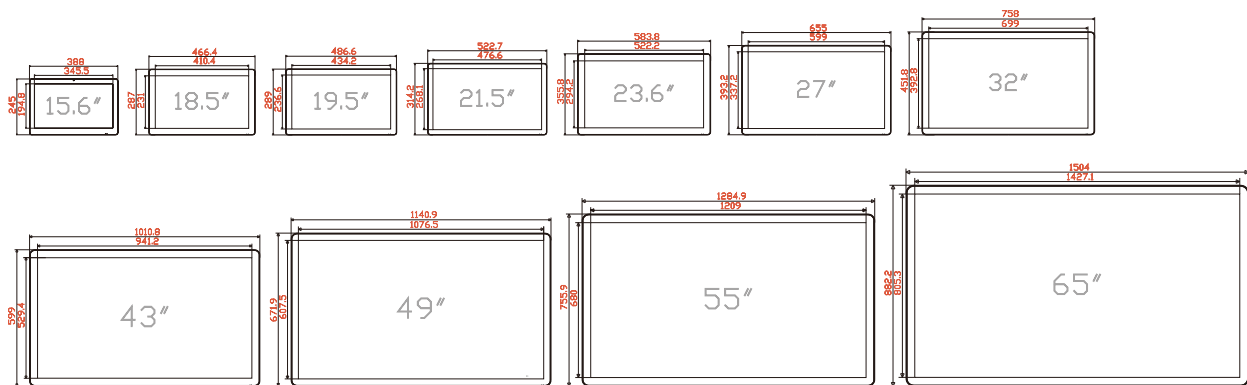

Front



Back

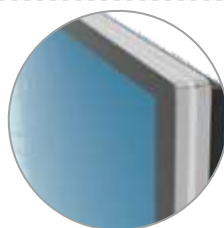

Side



Interface



Specifications (Touch)

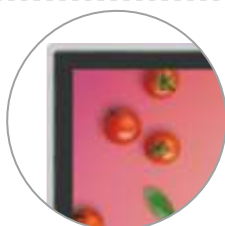
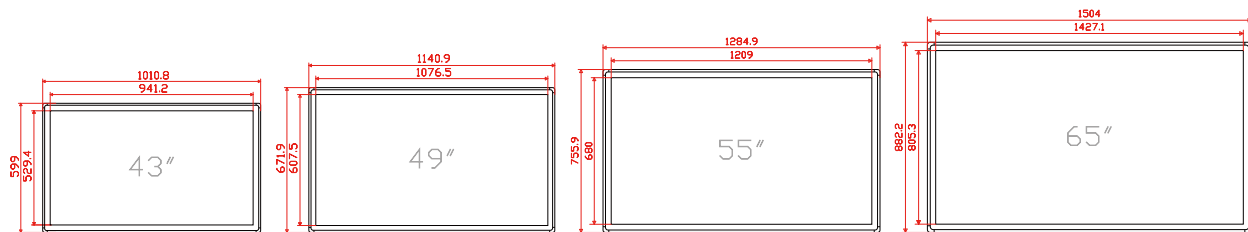

Front



Back



Side

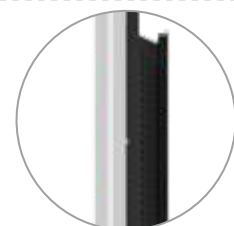

Interface

Technical Parameter

Product Model		US-AD*****			
Screen Parameters	Size	43"- 65"	Audio System	Horn	2x5W(8Ω)
	Back Type	Backlight Integration		Sound Mode	Standard
	Display Proportion	16:9	Output Interface	PC Output Interface	RJ45x1、USBx2
	Physical Resolution	1920X1080		L/R Audio Output	1 RCA X2
	Color Depth	16.7M	Power Consumption	Input Voltage	C 100~240v 50/60HZ
	Viewing Angle	R/L/U/D 89/89/89/89		Standby Power	≤3W / ≤180W
	Brightness	450 cd/m ²	Cabinet	Material	SPCC
	Contrast	5000:1		Exterior Color	Black / Gold / Silver
	Response Time	5ms	External Conditions	Working Temperature	0°C~50°C/20%~80%
	Service Time	60000 hours		Storage Temperature	-10°C~60°C/5--95%

Display Board Solution Options

Version	CPU	Internal Storage	Out Storage	Interface	System Supporting
Display Version	E9-B11/ E9-BNC/E6J-AV	No Storage	USB /HDD/SSD	HDMI/VGA/ DVI/USB	Android /Windows/ Linux OS
Standalone Version	Mstar V56	No Storage (8G/16G available)	Support SD card and USB Flash	HDMI/USB/SD	Only Standalone OS

Android OS Solution

Configuration	CPU	Chip Architecture	Processor	Max Resolution Support	System Version	Storage
Basic Level	A20	Cortex-A7	Dual-Core	1080P	Android 4.1	512Mb +8G
	A33	CortexTM-A7	Quad-Core	1080P	Android 4.4	512Mb/1Gb +8G
	A64	Cortex-A53	Quad-Core	1080P	Android 5.1	512Mb/1Gb +8G
Middle Level	RK3128	Cortex-A7	Quad-Core	1080P	Android 6.0	512Mb/1Gb +8G
	RK3368	Coretex-A53	Octa-Core	2K/4K	Android 6.0	1Gb/2Gb +8G
	RK3188	Cortex A9	Quad-Core	2K	Android 6.0	1Gb/2Gb +8G
Top Level	RK3288	Cortex-A17	Quad-Core	4K	Android 6.0	2Gb +8G
	RK3399	Cortex-A72	Dual-Core + Quad-Core	4K	Android 7.1	4Gb +16G
	Amlogic T960X	Cortex-A53	Version	4K	Android 7.1	2Gb +8G

Windows OS Solution

Operating System	CPU	System Version	Graphics	RAM	Storage
Windows OS	Core-i3	Win 7/ Win 10	3.7HZ/3.9HZ	4G (8G available)	120G SSD/ 500G HDD
	Core-i5	Win 7/ Win 10	3.2HZ/3.4HZ	4G (8G available)	120G SSD/ 500G HDD
	Core-i7	Win 7/ Win 10	3.4HZ/3.6HZ	4G (8G available)	120G SSD/ 500G HDD